

TOP VIEW

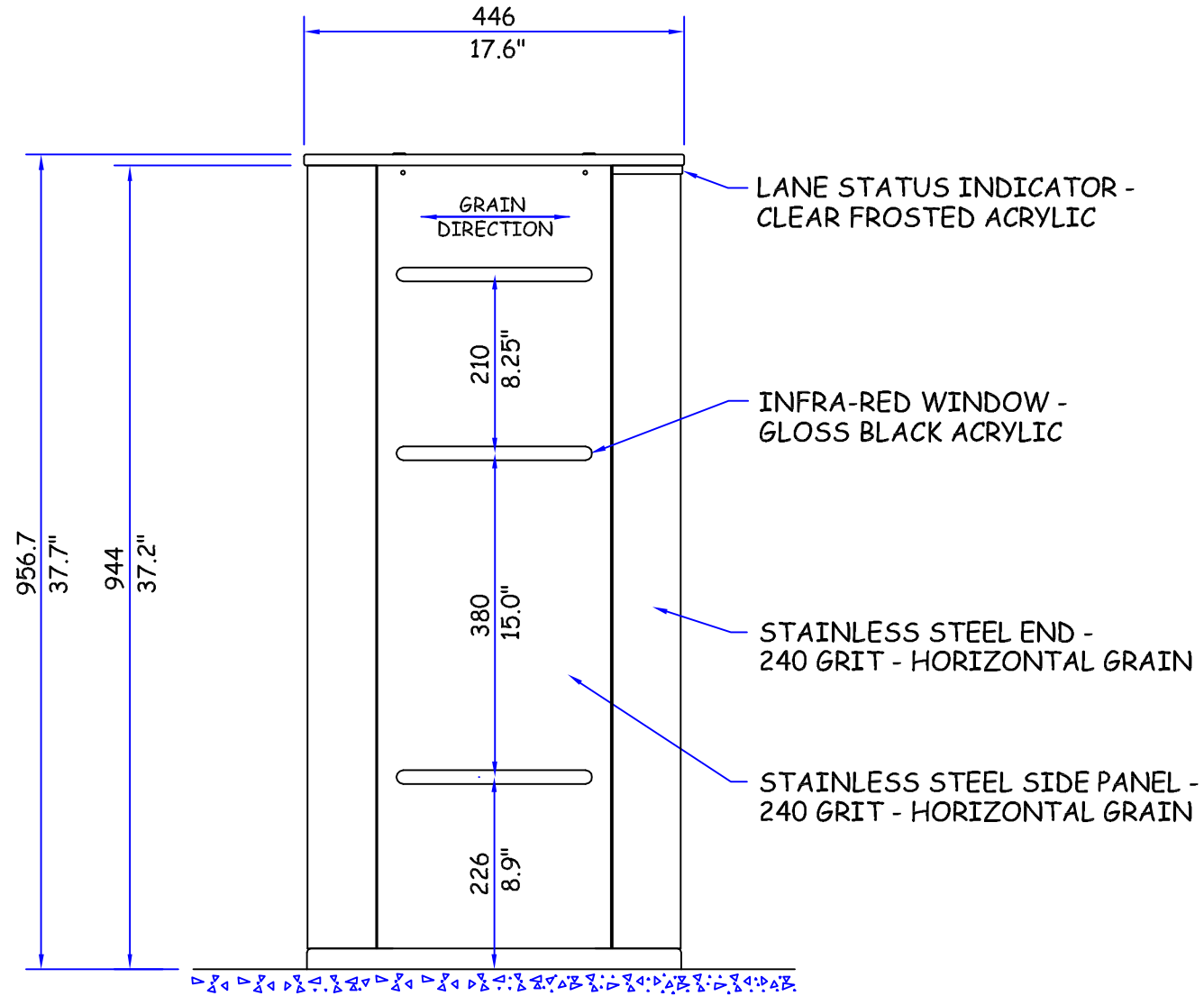

SIDE VIEW

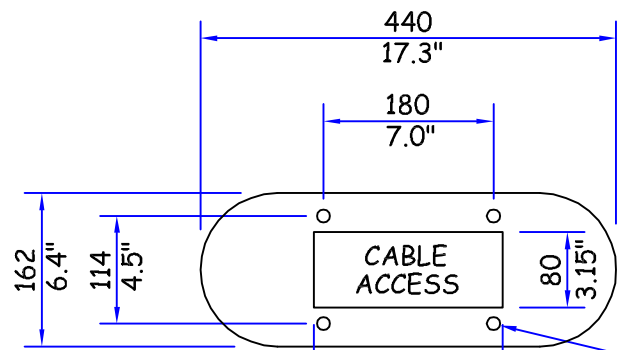

4 FIXING HOLES 14 DIA (0.55") FOR M10 (3/8") FIXINGS SUITABLE FOR FLOOR STRUCTURE

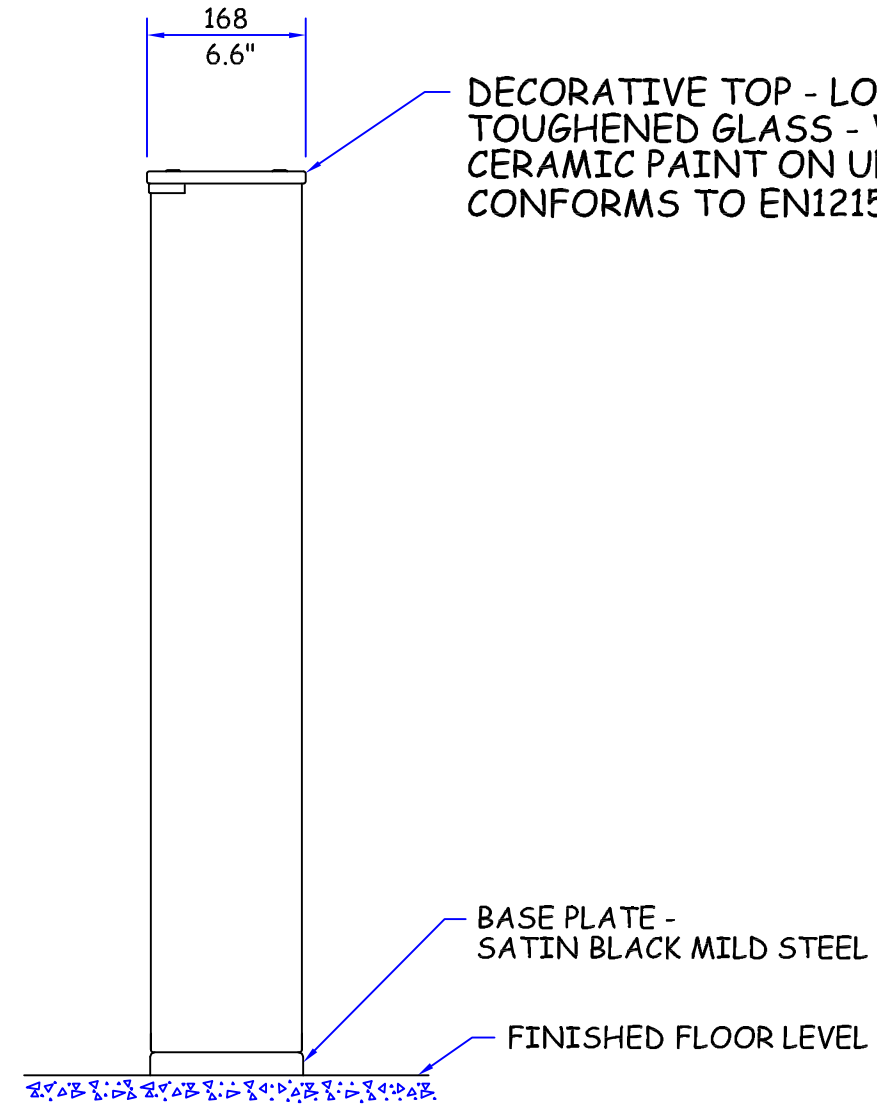

END VIEW

DECORATIVE TOP - LOW IRON TOUGHENED GLASS - WHITE CERAMIC PAINT ON UNDERSIDE CONFORMS TO EN12150 & EN12600

BASE PLATE - SATIN BLACK MILD STEEL

FINISHED FLOOR LEVEL

PRODUCT: FASTLANE COMPACT		
TITLE: GENERAL DIMENSIONS		
DRAWN: RST	DRAWING No: S665_670_A0	
DATE: 19.9.07	This document is the copyright of Integrated Design Ltd	

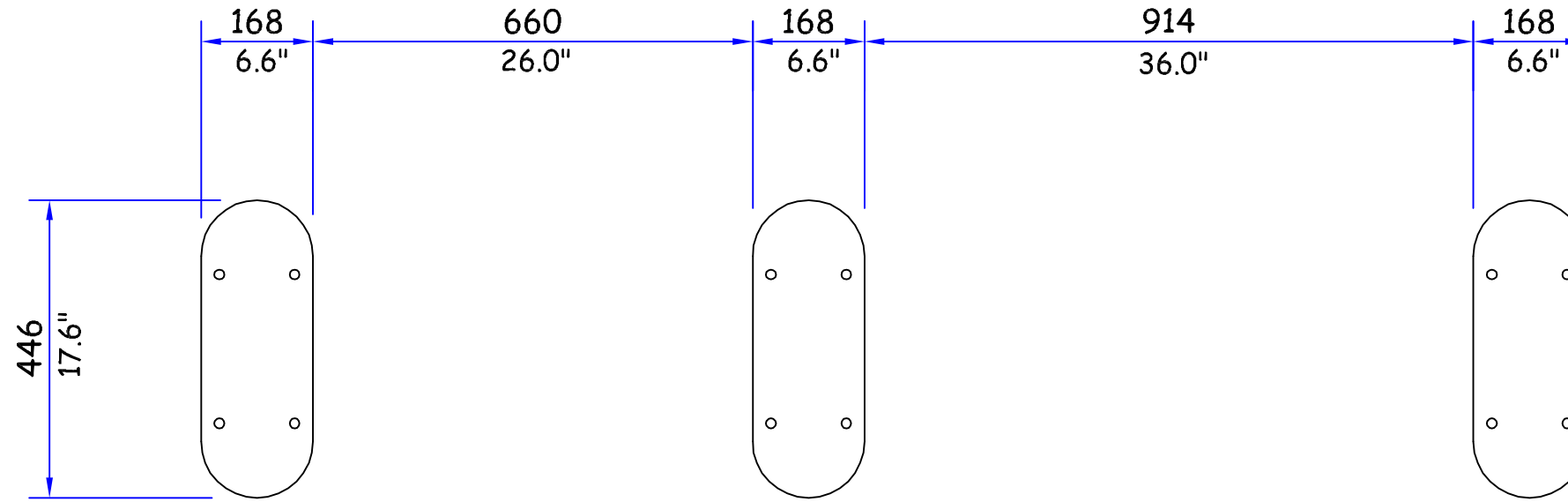

STANDARD LANE WIDTH
PEDESTRIAN ACCESS

EXTENDED LANE WIDTH
* DISABLED ACCESS

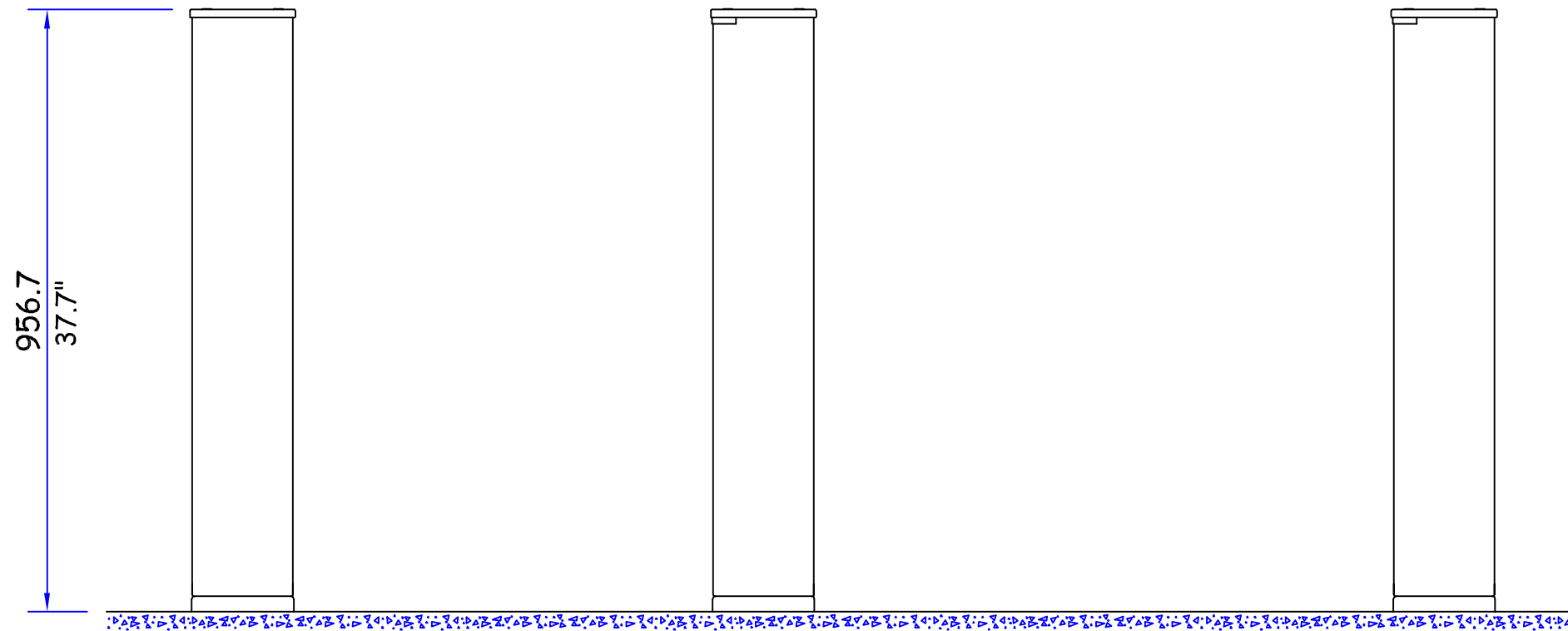

* SUBJECT TO LOCAL LEGISLATION

THIS DRAWING SHOWS TYPICAL LANE WIDTHS.
LANES CAN BE BETWEEN 600mm & 1000mm. (23.6" & 39.4")

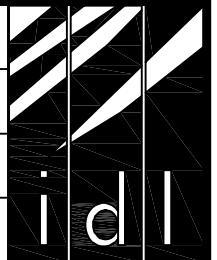
PRODUCT: FASTLANE COMPACT		
TITLE: GENERAL LAYOUT		
DRAWN: RST	DRAWING No: S665_671_A0	
DATE: 20.3.08	This document is the copyright of Integrated Design Ltd	

CARD READER POSITION - OPTION 1
MOUNTED BELOW GLASS TOP

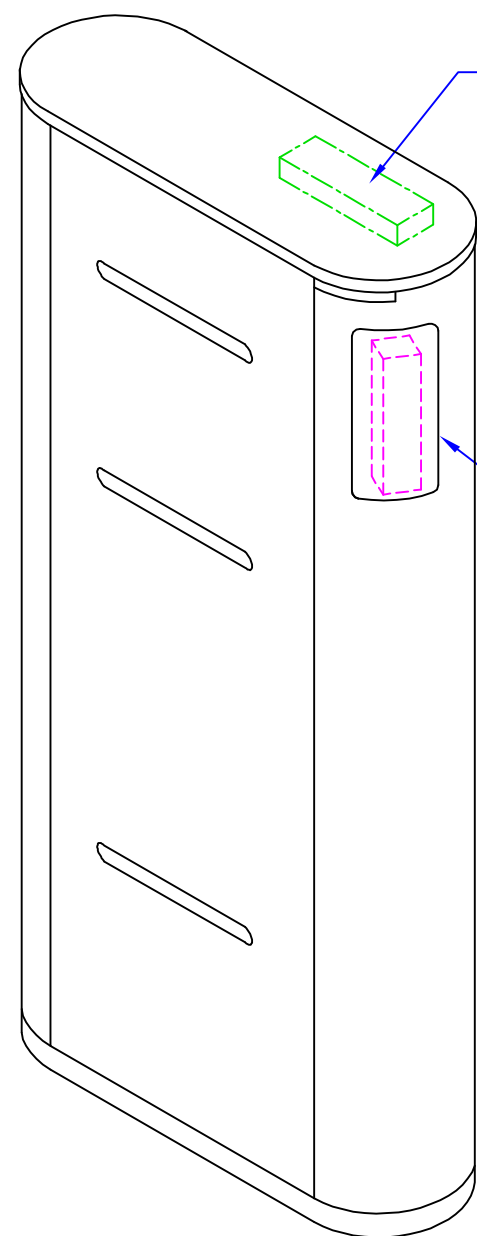
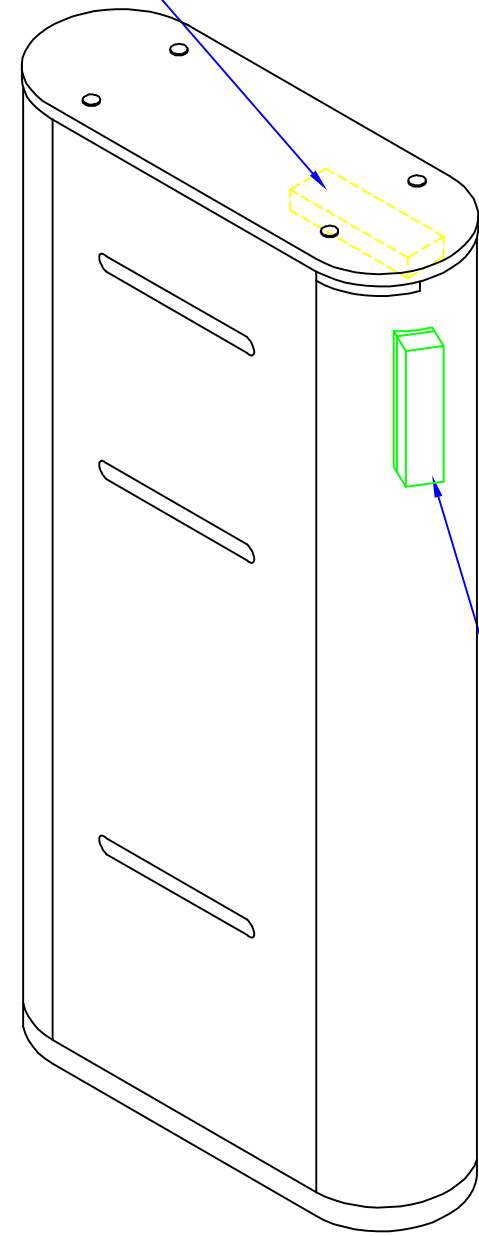
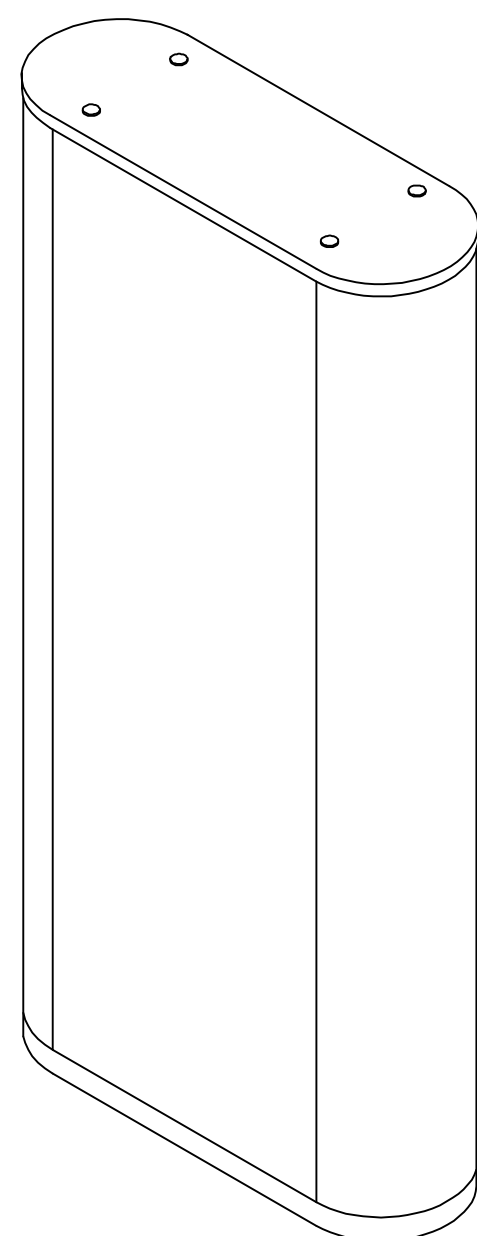

CARD READER POSITION - OPTION 2
MOUNTED EXTERNALLY ON CORIAN TOP

CARD READER POSITION - OPTION 4
MOUNTED BEHIND FROSTED ACRYLIC WINDOW

CARD READER POSITION - OPTION 3
MOUNTED EXTERNALLY ON BLOCK

PRODUCT: FASTLANE COMPACT	
TITLE: CARD READER OPTIONS	
DRAWN: RST	DRAWING No: S665_673_A0
DATE: 19.9.07	This document is the copyright of Integrated Design Ltd

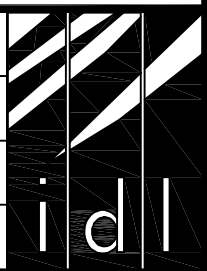

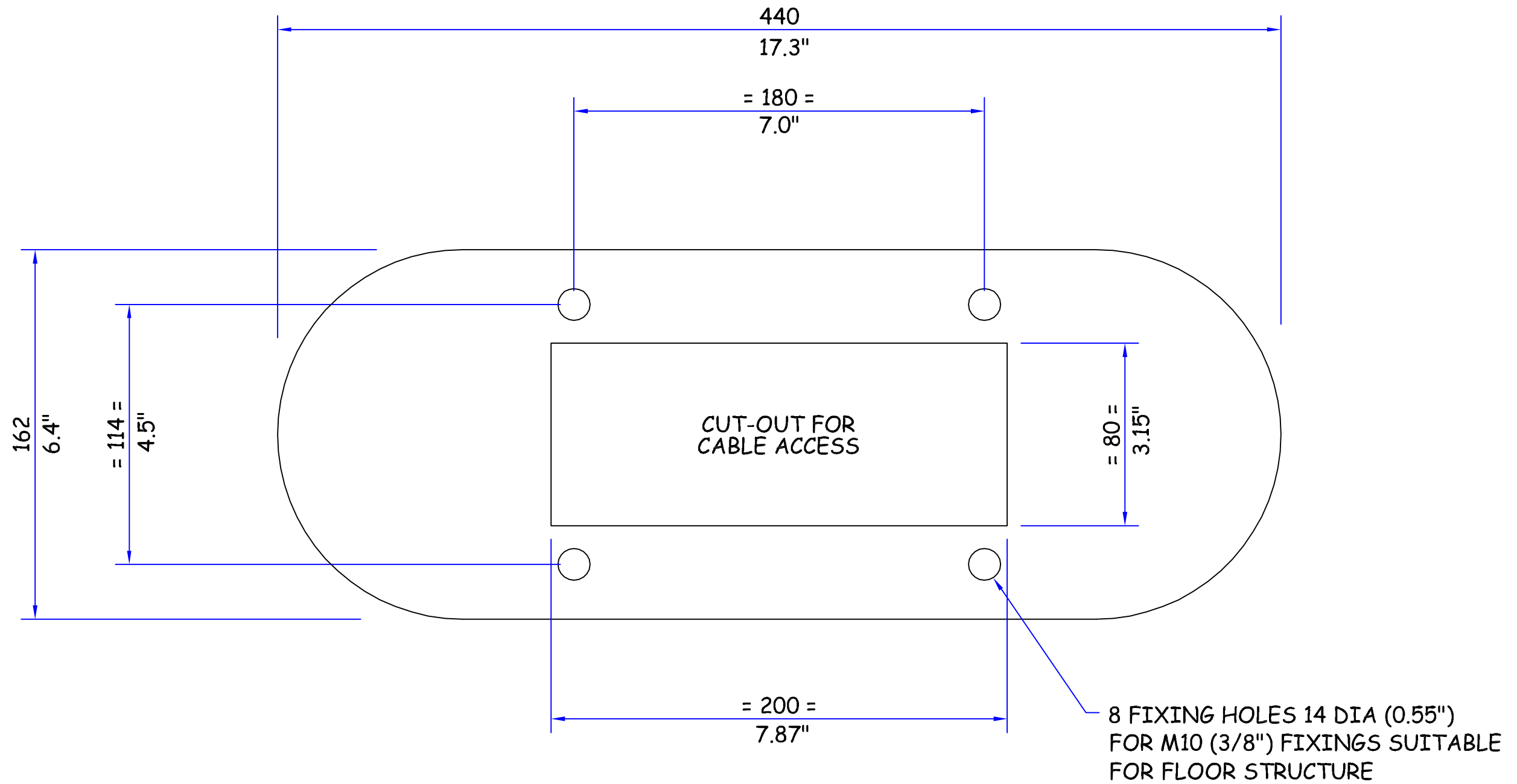

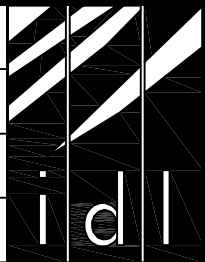
PRODUCT: FASTLANE COMPACT		
TITLE: BASE DRILLING TEMPLATE		
DRAWN: RST	DRAWING No: S665_675_A0	
DATE: 19.9.07	This document is the copyright of Integrated Design Ltd	

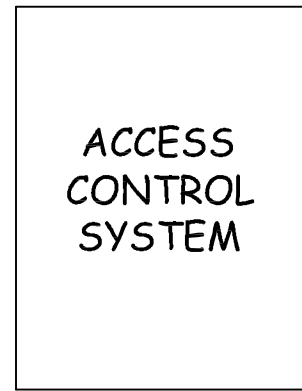

- * CARD READER
- ACCESS CONTROL
- ACCESS CONTROL
- * CARD READER
- * CARD READER
- * CARD READER

ACCESS CONTROL - 10 CORE

- <IP 'DOOR OPEN' ENTRY
- IP> 'DOOR OPEN' EXIT
- <ENT 'DOOR CLOSED' ENTRY
- ENT> 'DOOR CLOSED' EXIT
- AL1 ALARM O/P N/C
- AL2 ALARM O/P N/O

* CARD READER CABLING DEPENDENT ON READER MANUFACTURER'S SPECIFICATIONS.

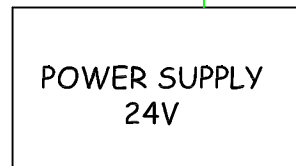
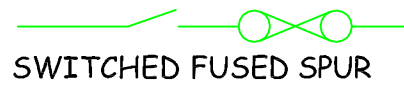

TRANSMIT ENCLOSURE

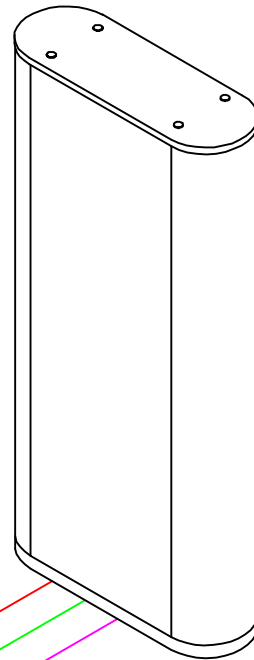

INTERLANE ENCLOSURE

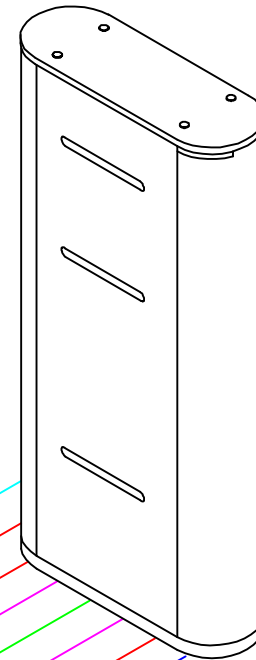

RECEIVE ENCLOSURE

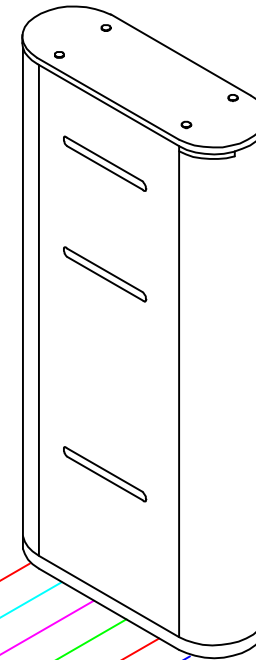

2 CORE

CAT. 5 CABLE (3 MTRS SUPPLIED) (10')

2 CORE

CAT. 5 CABLE (3 MTRS SUPPLIED) (10')

2 CORE

8 CORE + SCREEN



8 CORE + SCREEN



PRODUCT: FASTLANE COMPACT		
TITLE: CABLING REQUIREMENTS		
DRAWN: RST	DRAWING No: S665_677_A0	
DATE: 19.9.07	This document is the copyright of Integrated Design Ltd	