

PRODUCT: FASTLANE PLUS R400 OT		
TITLE: GENERAL DIMENSIONS		
DRAWN: RST	DRAWING No: S665_630_A0	
DATE: 20.1.09	This document is the copyright of Integrated Design Ltd	

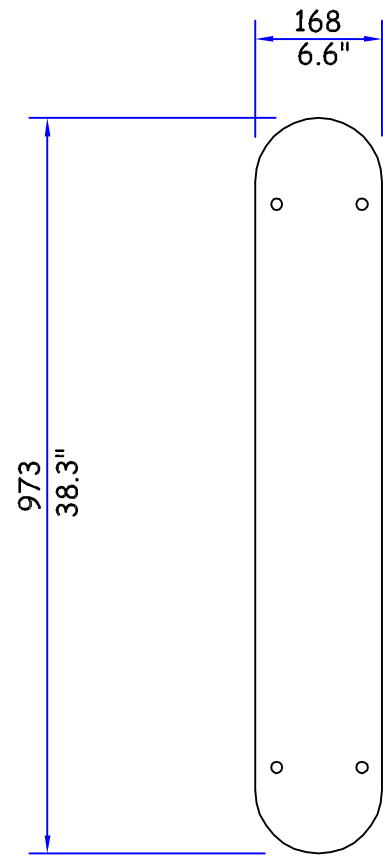

STANDARD LANE WIDTH
STANDARD ACCESS

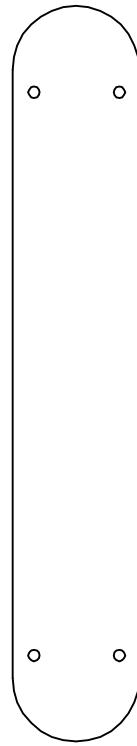

EXTENDED LANE WIDTH
* DISABLED ACCESS

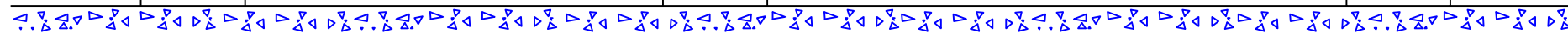
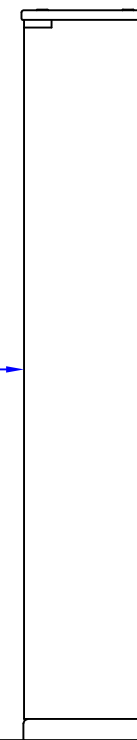
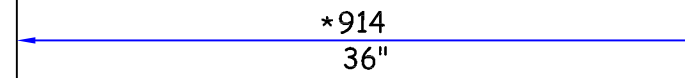
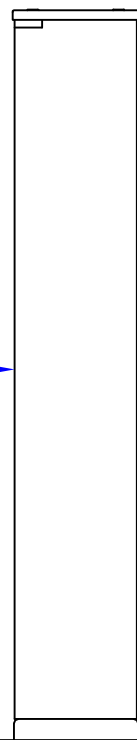
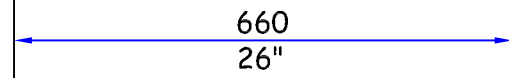
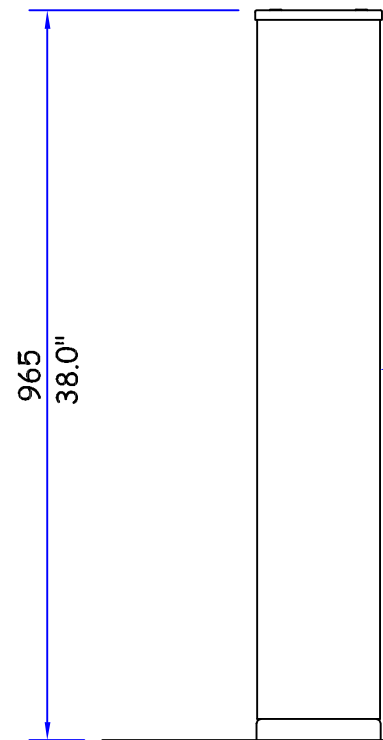

* SUBJECT TO LOCAL LEGISLATION

PRODUCT: FASTLANE PLUS R400 OT	
TITLE: GENERAL LAYOUT	
DRAWN: RST	DRAWING No: S665_631_A1
DATE: 20.1.09	This document is the copyright of Integrated Design Ltd

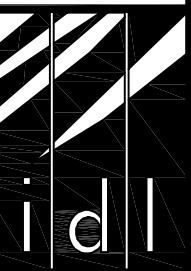

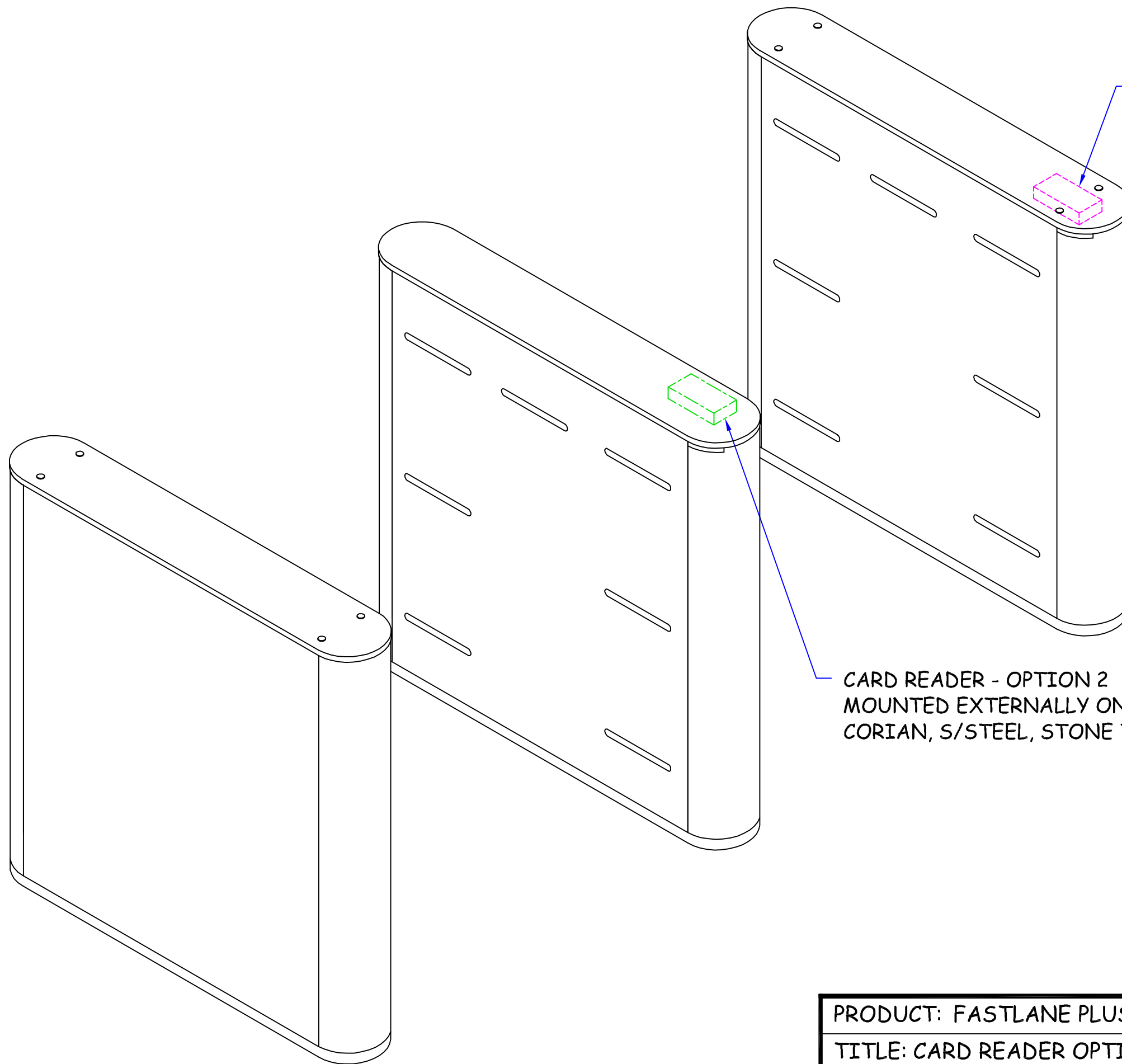

CARD READER - OPTION 1
 MOUNTED BELOW GLASS TOP
 AVAILABLE AREA 250 x 115 x 70
 (10" x 4.5" x 2.75" APPROX.)

CARD READER - OPTION 2
 MOUNTED EXTERNALLY ON
 CORIAN, S/STEEL, STONE TOP

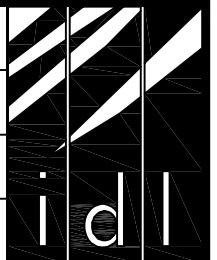
PRODUCT: FASTLANE PLUS R400 OT		
TITLE: CARD READER OPTIONS		
DRAWN: RST	DRAWING No: S665_633_A0	
DATE: 20.1.09	This document is the copyright of Integrated Design Ltd	

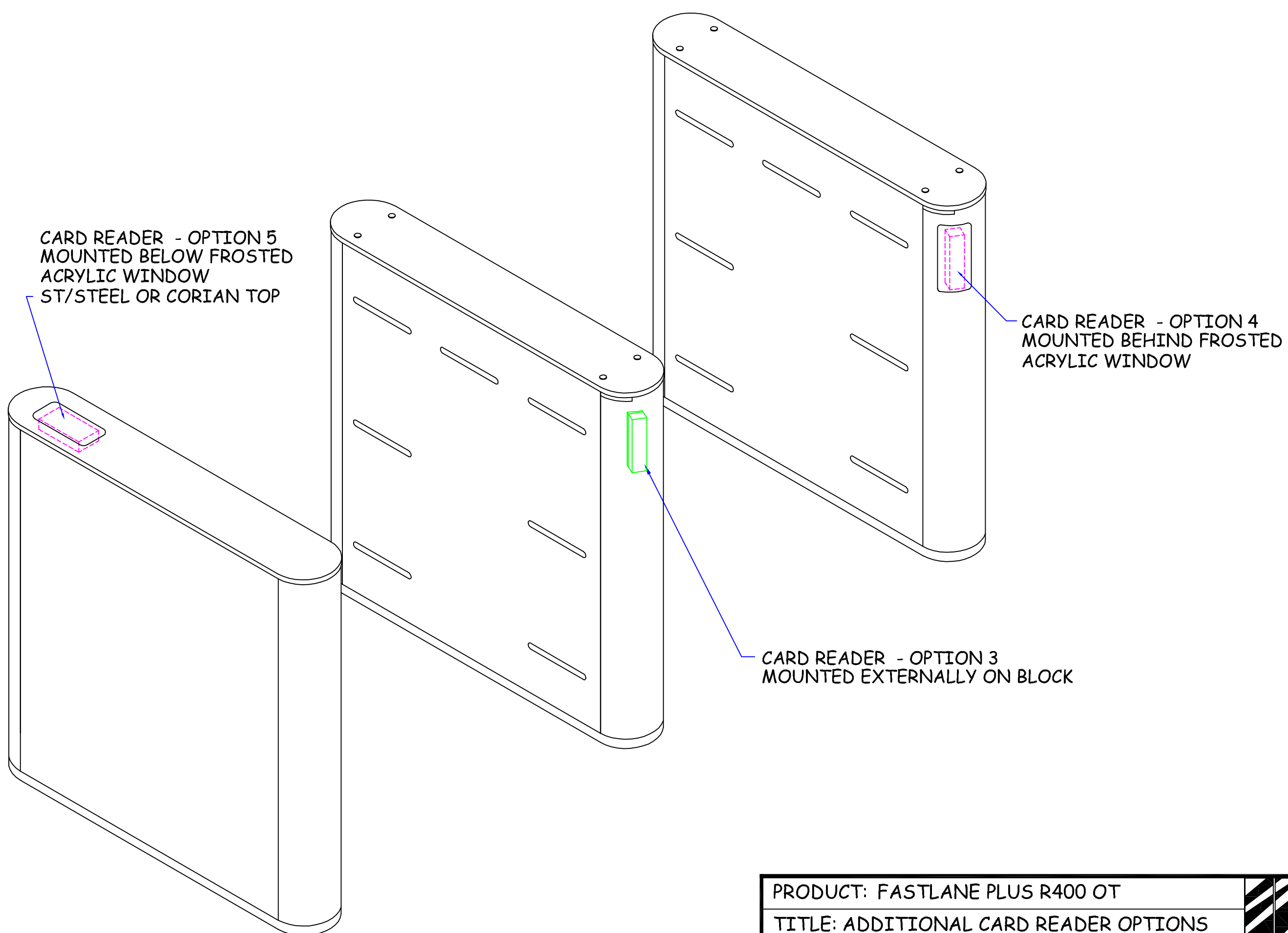

CARD READER - OPTION 5
MOUNTED BELOW FROSTED
ACRYLIC WINDOW
ST/STEEL OR CORIAN TOP

CARD READER - OPTION 4
MOUNTED BEHIND FROSTED
ACRYLIC WINDOW

CARD READER - OPTION 3
MOUNTED EXTERNALLY ON BLOCK

PRODUCT: FASTLANE PLUS R400 OT	
TITLE: ADDITIONAL CARD READER OPTIONS	
DRAWN: RST	DRAWING No: S665_634_A0
DATE: 20.1.09	This document is the copyright of Integrated Design Ltd

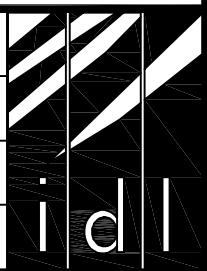

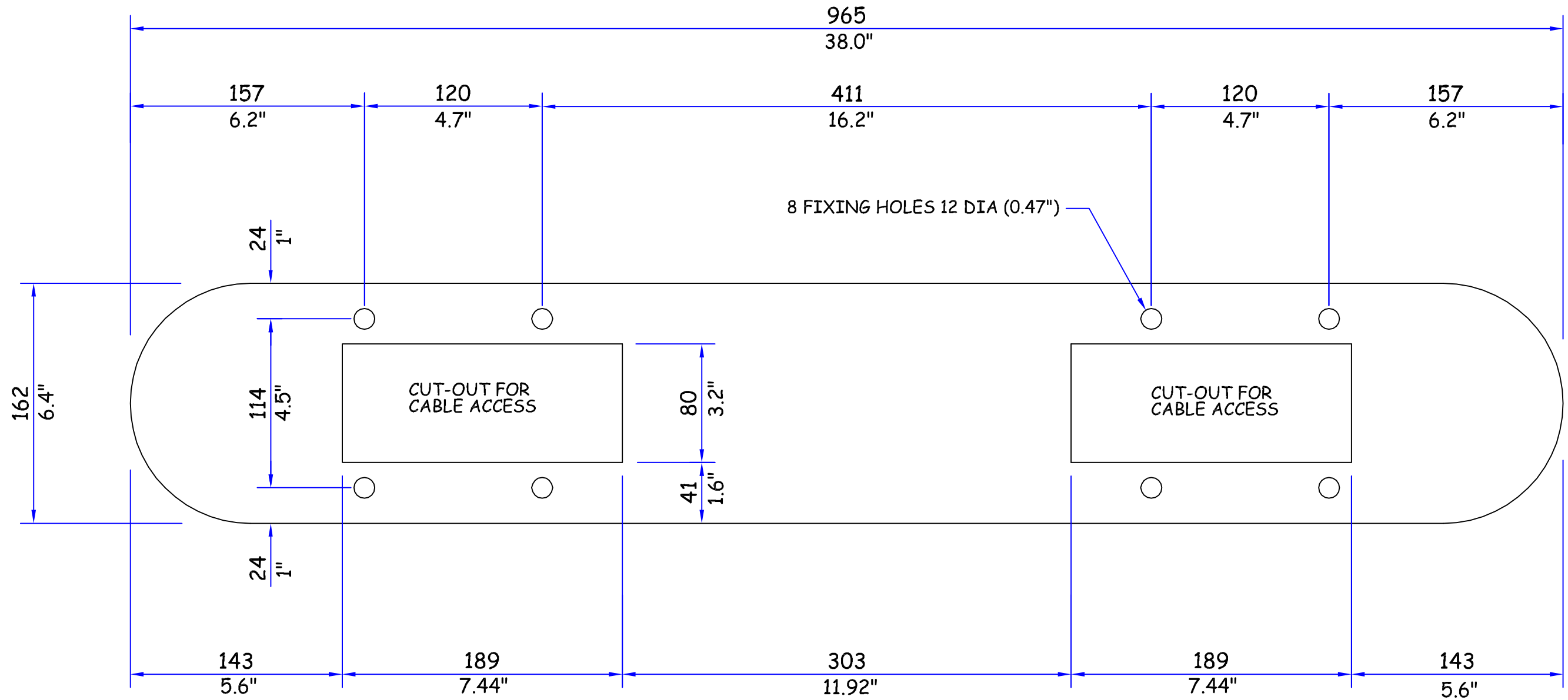

NOTE: UNIT IS TO BE SECURED TO THE FLOOR USING 10mm (0.39") DIA FIXINGS SUITABLE FOR THE FLOOR STRUCTURE.

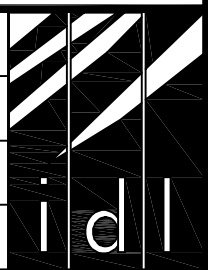
PRODUCT: FASTLANE PLUS R400 OT		
TITLE: BASE DRILLING TEMPLATE		
DRAWN: RST	DRAWING No: S665_635_A0	
DATE: 20.1.09	This document is the copyright of Integrated Design Ltd	

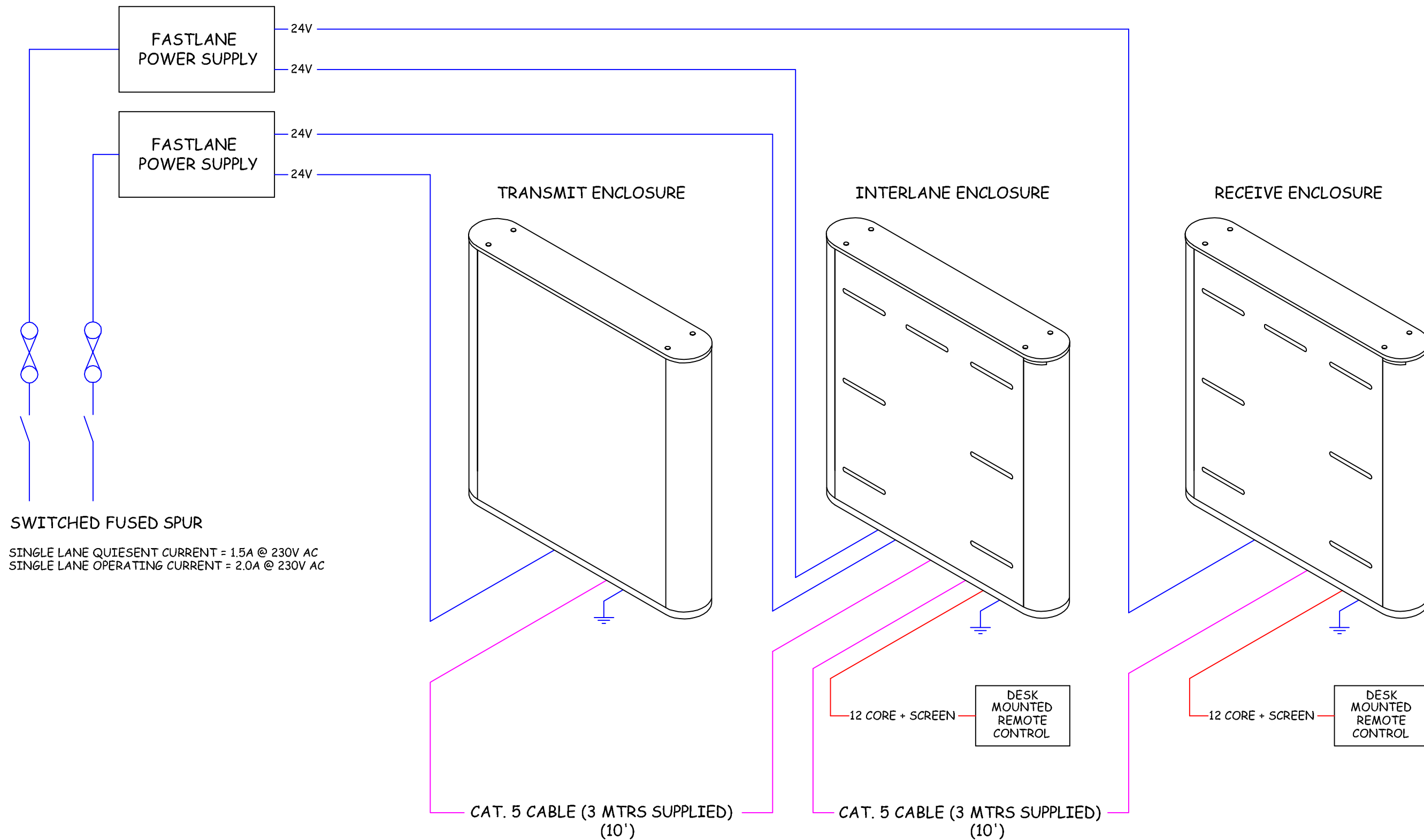

THIS DRAWING SHOWS THE FASTLANE PLUS CABLING REQUIREMENTS. IT IS TO BE READ IN CONJUNCTION WITH DRAWING 665_637_A0, WHICH SHOWS THE CABLING REQUIREMENTS FOR THE ACCESS CONTROL INTEGRATION. FOR FURTHER INFORMATION, REFER TO THE INSTALLATION MANUAL.

PRODUCT: FASTLANE PLUS R400 OT		
TITLE: CABLING REQUIREMENTS		
DRAWN: RST	DRAWING No: S665_637_A0	
DATE: 20.1.09	This document is the copyright of Integrated Design Ltd	

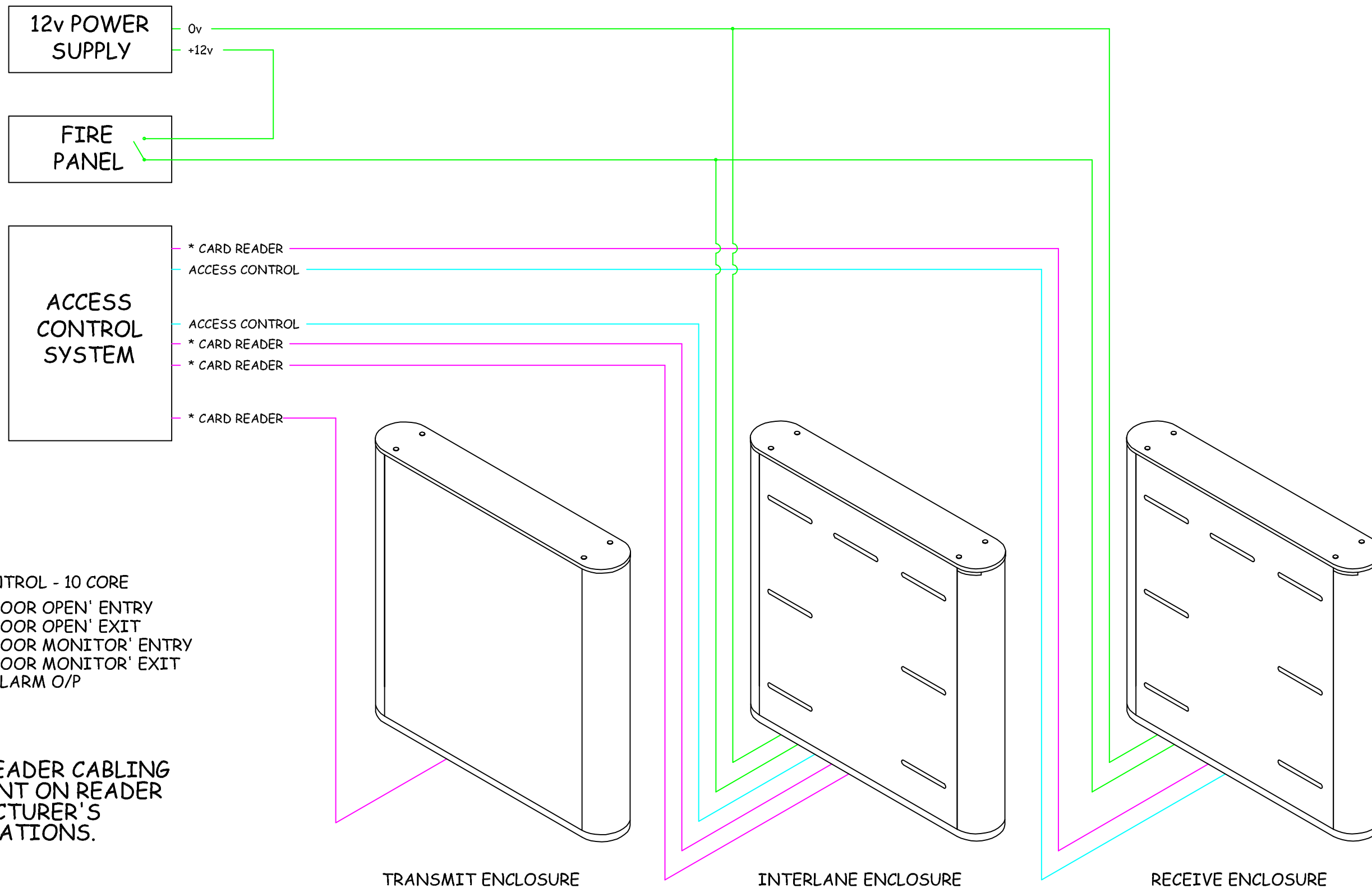

ACCESS CONTROL - 10 CORE

<IP 'DOOR OPEN' ENTRY

IP> 'DOOR OPEN' EXIT

<ENT 'DOOR MONITOR' ENTRY

ENT> 'DOOR MONITOR' EXIT

ALR ALARM O/P

* CARD READER CABLING DEPENDENT ON READER MANUFACTURER'S SPECIFICATIONS.

THIS DRAWING SHOWS THE ACCESS CONTROL INTEGRATION REQUIREMENTS. IT IS TO BE READ IN CONJUNCTION WITH DRAWING 665_637_A0 WHICH SHOWS THE FASTLANE PLUS CABLING REQUIREMENTS.

FOR FURTHER INFORMATION, REFER TO THE INSTALLATION MANUAL.

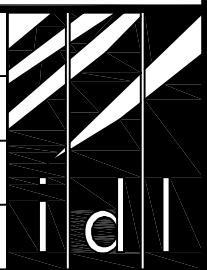
PRODUCT: FASTLANE PLUS R400 OT		
TITLE: CABLING REQUIREMENTS		
DRAWN: RST	DRAWING No: S665_638_A0	
DATE: 20.1.09	This document is the copyright of Integrated Design Ltd	