

OVERALL FINISHED WEIGHT OF PEDESTAL - TBA

PRODUCT: GLASSWING STANDARD - ELLIPTICAL	
TITLE: GENERAL DIMENSIONS	
DRAWN: DSC	DRAWING No: S665_530_A0
DATE: 30.4.08	This document is the copyright of Integrated Design Ltd

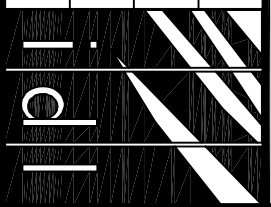

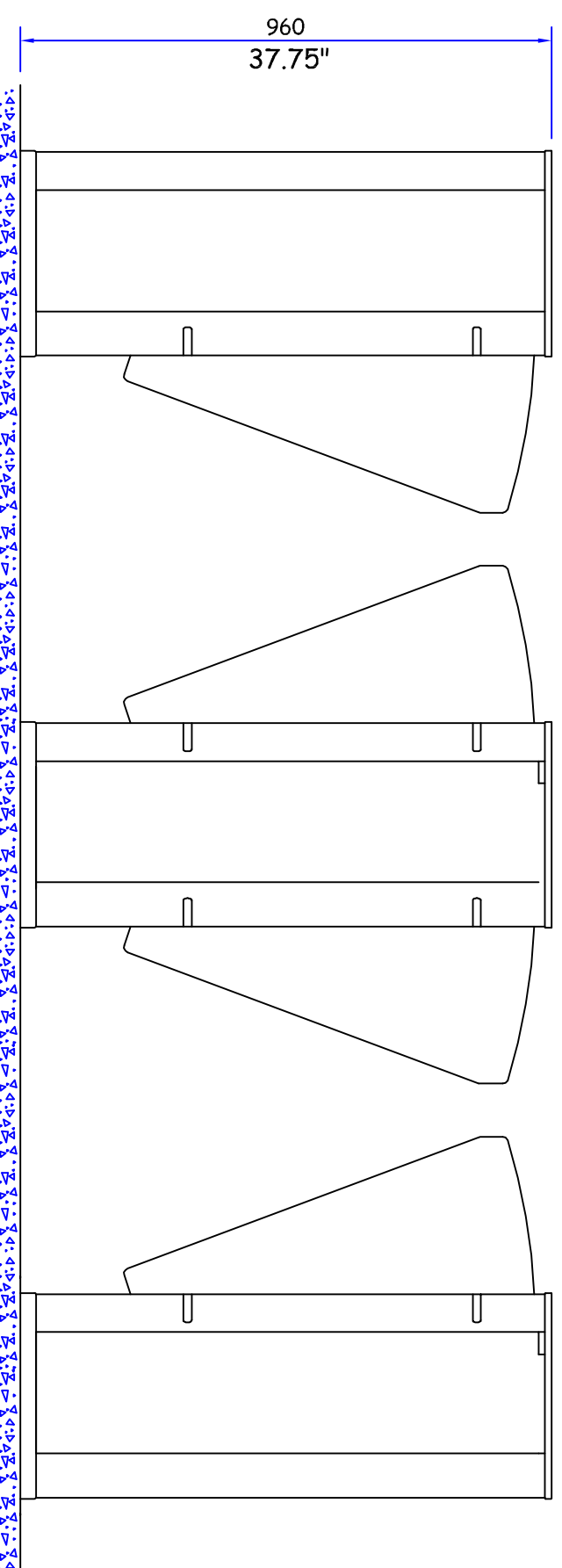
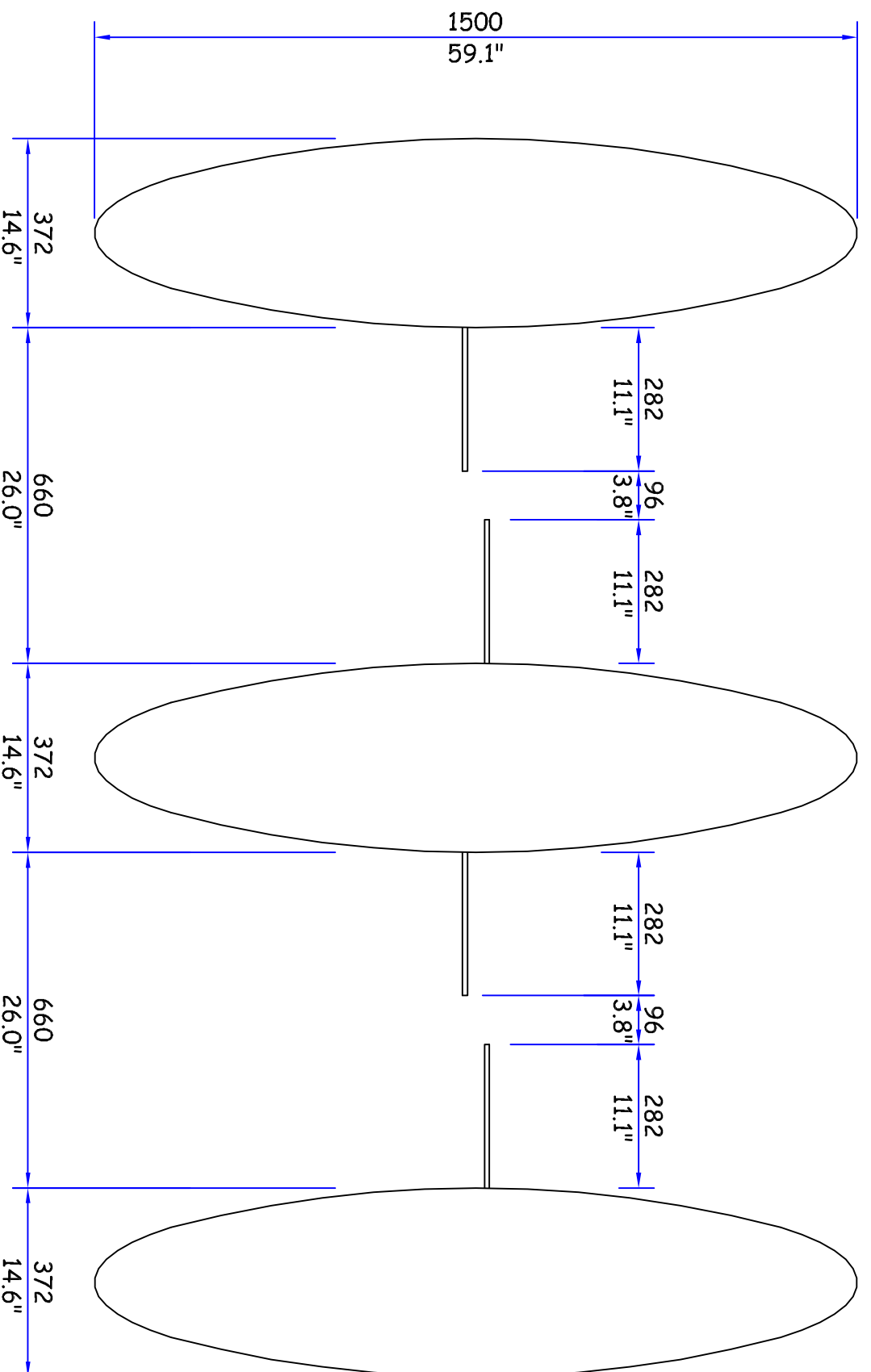

PRODUCT: GLASSWING STANDARD - ELLIPTICAL	
TITLE: GENERAL LAYOUT	
DRAWN: DSC	DRAWING No: 5665_531_A0
DATE: 30.4.08	This document is the copyright of Integrated Design Ltd

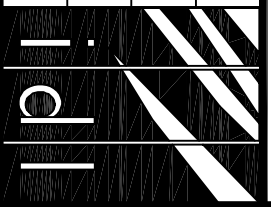

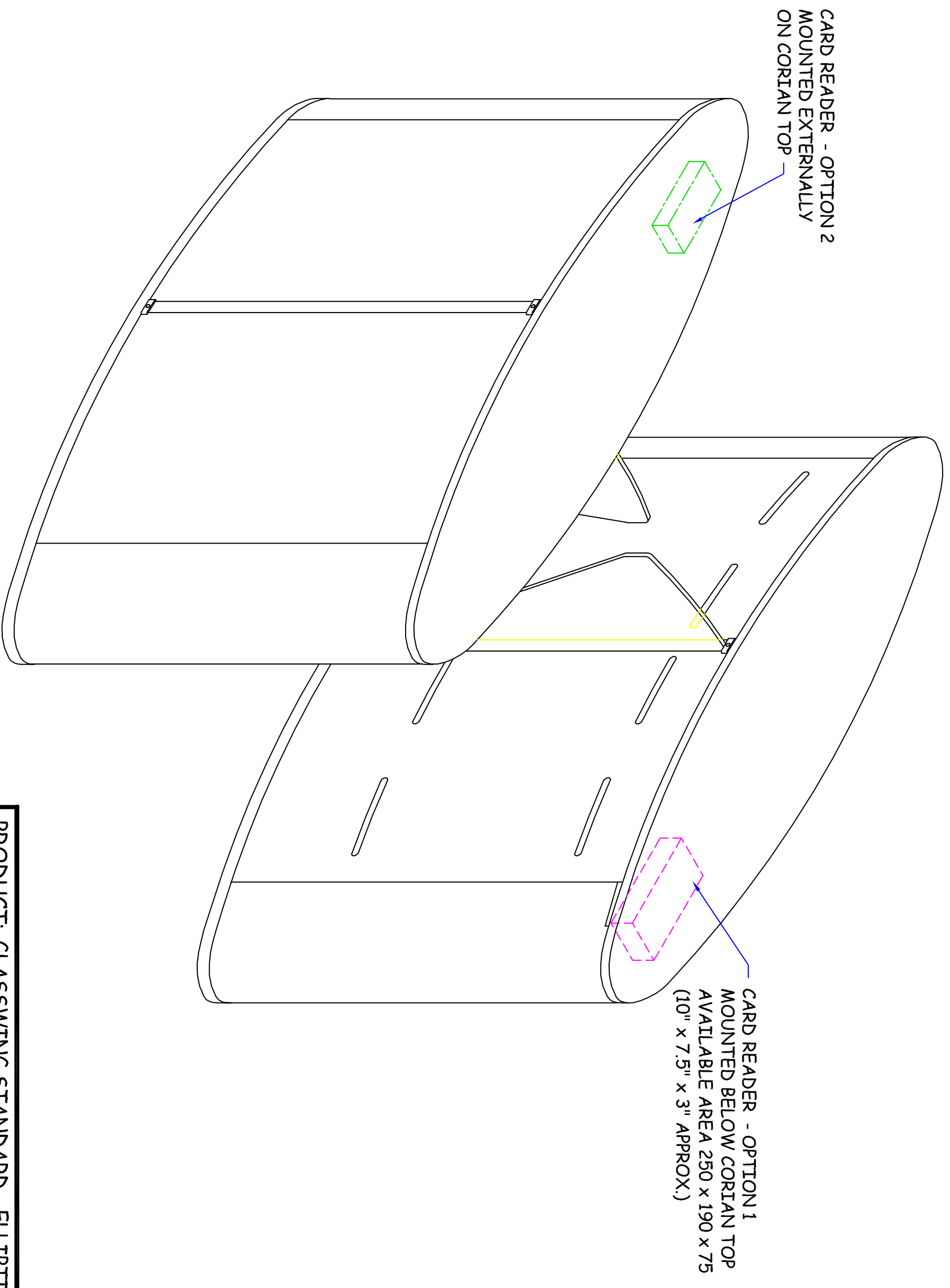

PRODUCT: GLASSWING STANDARD - ELLIPTICAL	
TITLE: CARD READER OPTIONS	
DRAWN: DSC	DRAWING No: S665_533_A0
DATE: 30.4.08	This document is the copyright of Integrated Design Ltd

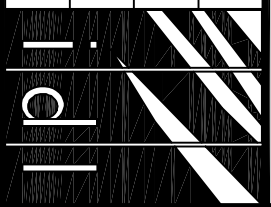

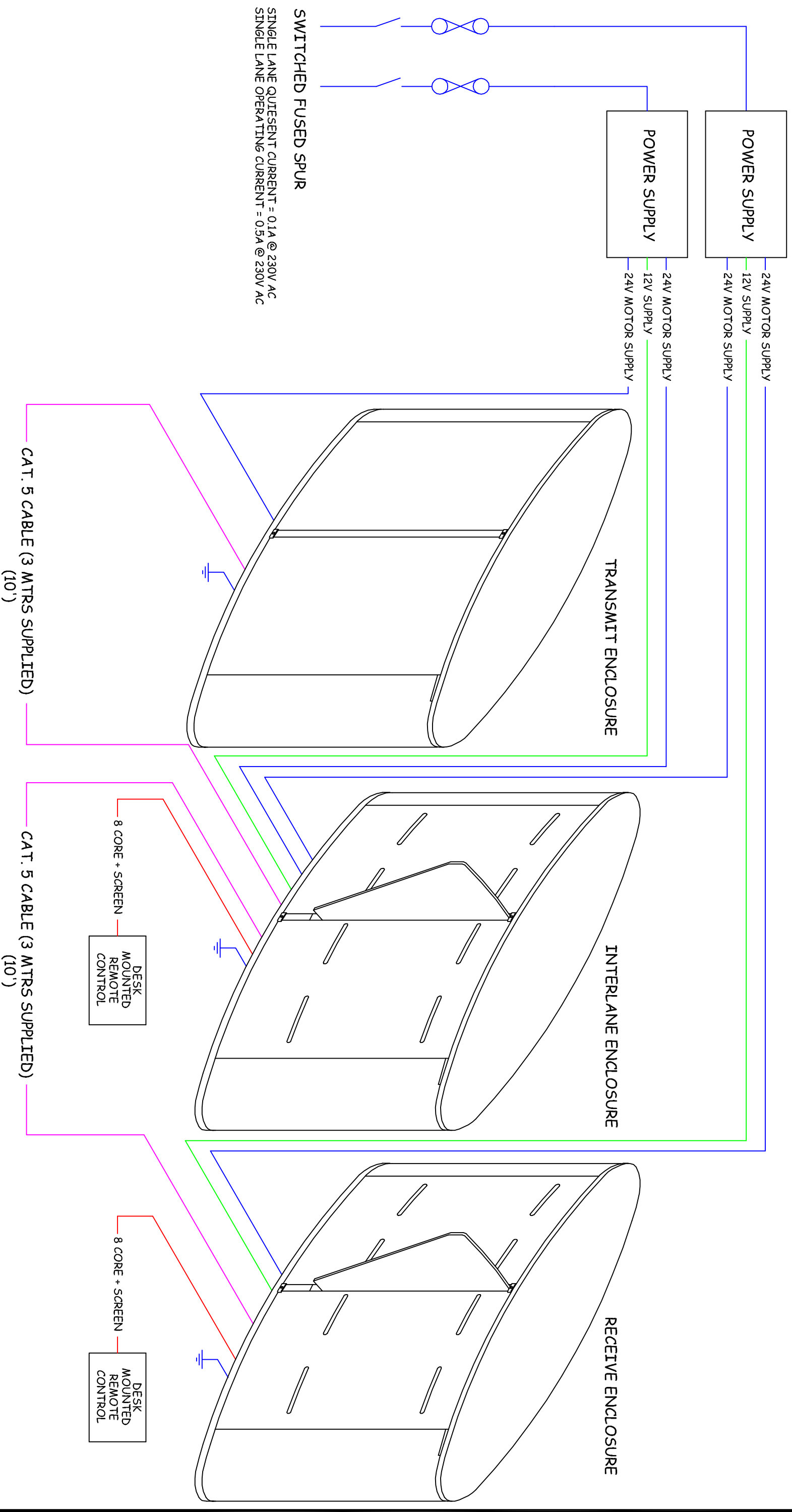

THIS DRAWING SHOWS THE GLASSWING CABLING REQUIREMENTS. IT IS TO BE READ IN CONJUNCTION WITH DRAWING 665_538_A0, WHICH SHOWS THE CABLING REQUIREMENTS FOR THE ACCESS CONTROL INTEGRATION. FOR FURTHER INFORMATION, REFER TO THE INSTALLATION MANUAL.

PRODUCT: GLASSWING STANDARD - ELLIPTICAL	
TITLE: CABLING REQUIREMENTS	
DRAWN: DSC	DRAWING No: 5665_537_A0
DATE: 30.4.08	

This document is the copyright of
Integrated Design Ltd



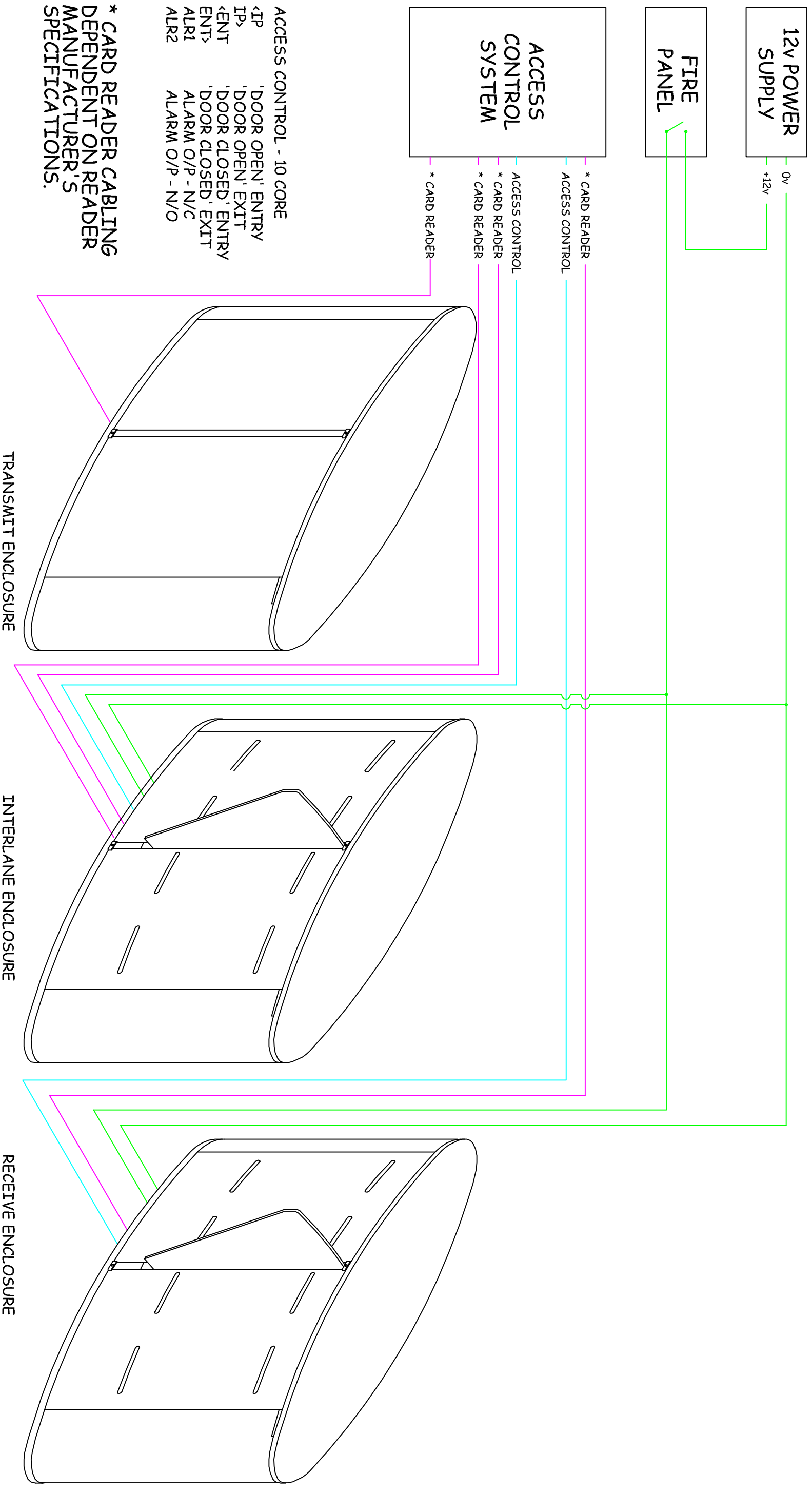

THIS DRAWING SHOWS THE ACCESS CONTROL INTEGRATION REQUIREMENTS. IT IS TO BE READ IN CONJUNCTION WITH DRAWING 665_537_A0 WHICH SHOWS THE GLASSWING CABLING REQUIREMENTS.

FOR FURTHER INFORMATION, REFER TO THE INSTALLATION MANUAL.

PRODUCT: GLASSWING STANDARD - ELLIPTICAL	
TITLE: CABLING REQUIREMENTS	
DRAWN: DSC	DRAWING No: 5665_538_A0
DATE: 30.4.08	

This document is the copyright of
Integrated Design Ltd

