

OVERALL FINISHED WEIGHT OF PEDESTAL - TBA

PRODUCT: GLASSWING STANDARD	
TITLE: GENERAL DIMENSIONS	
DRAWN: RST	DRAWING No: 5665_480_A0
DATE: 27.3.08	This document is the copyright of Integrated Design Ltd

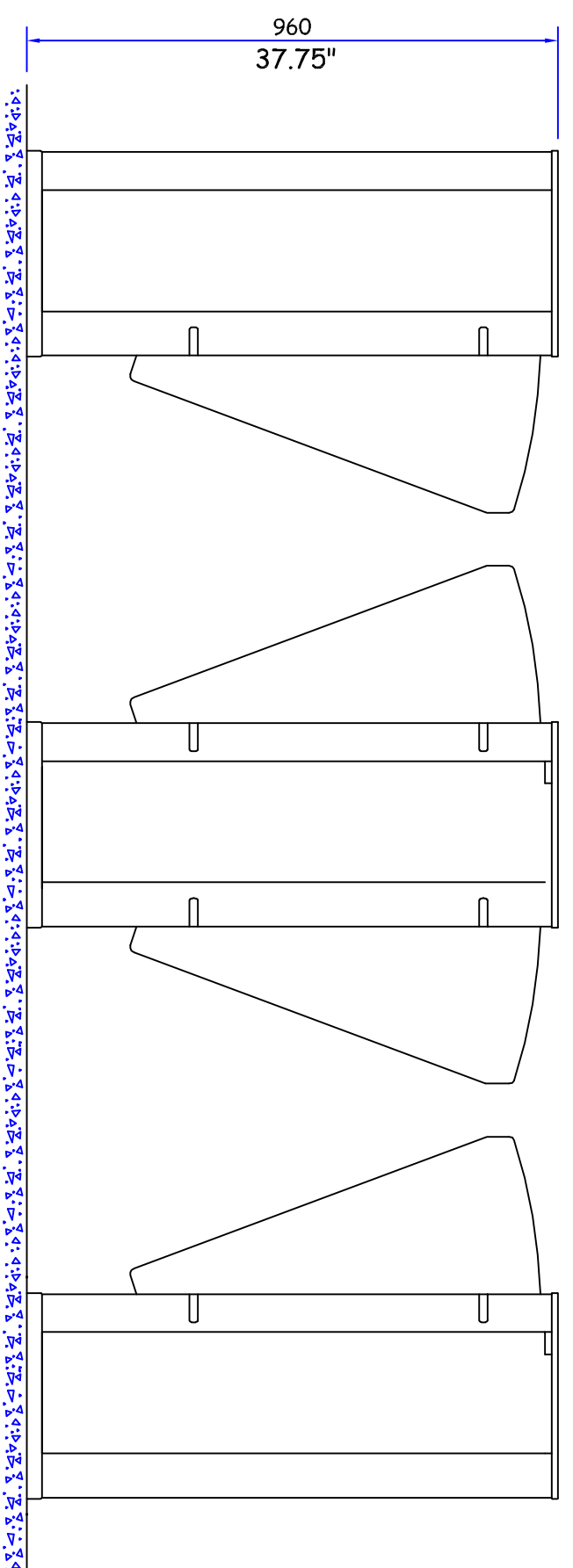

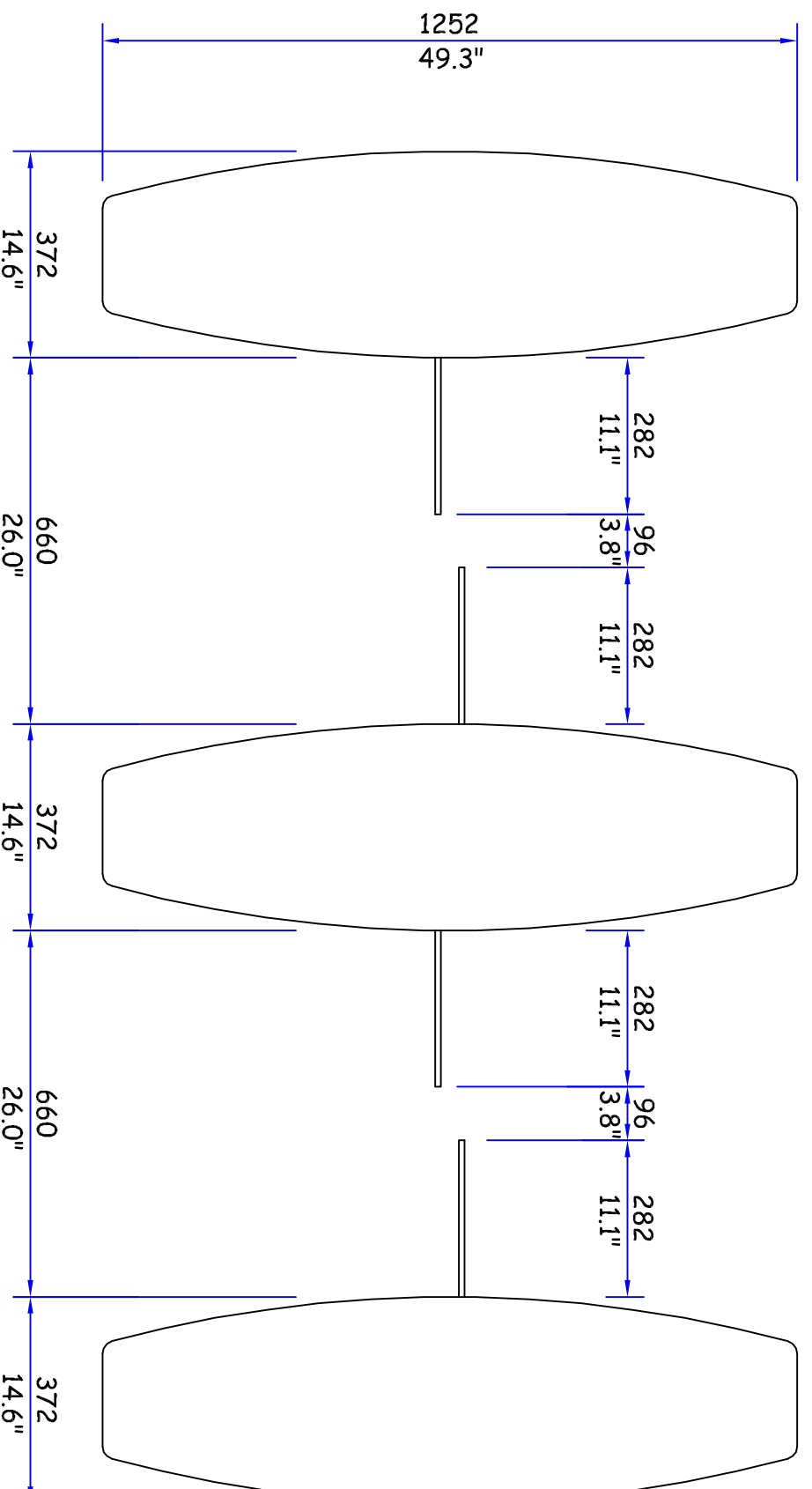

PRODUCT: GLASSWING STANDARD	
TITLE: GENERAL LAYOUT	
DRAWN: RST	DRAWING No: 5665_481_A0
DATE: 27.3.08	This document is the copyright of Integrated Design Ltd

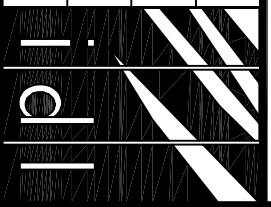

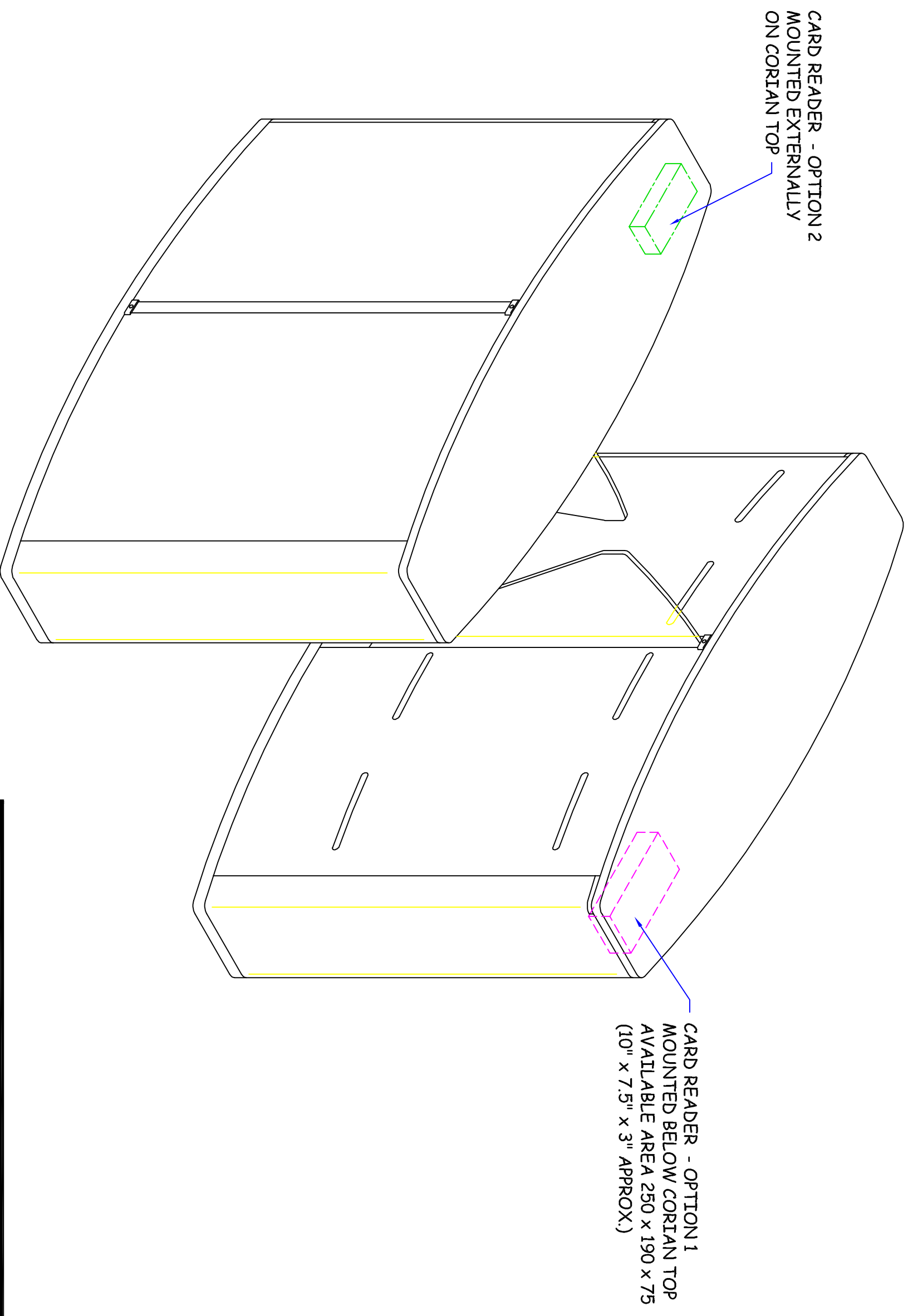

PRODUCT: GLASSWING DDA

TITLE: CARD READER OPTIONS

DRAWN: RST DRAWING No: 5665\_483\_A0

DATE: 27.3.08

This document is the copyright of  
Integrated Design Ltd



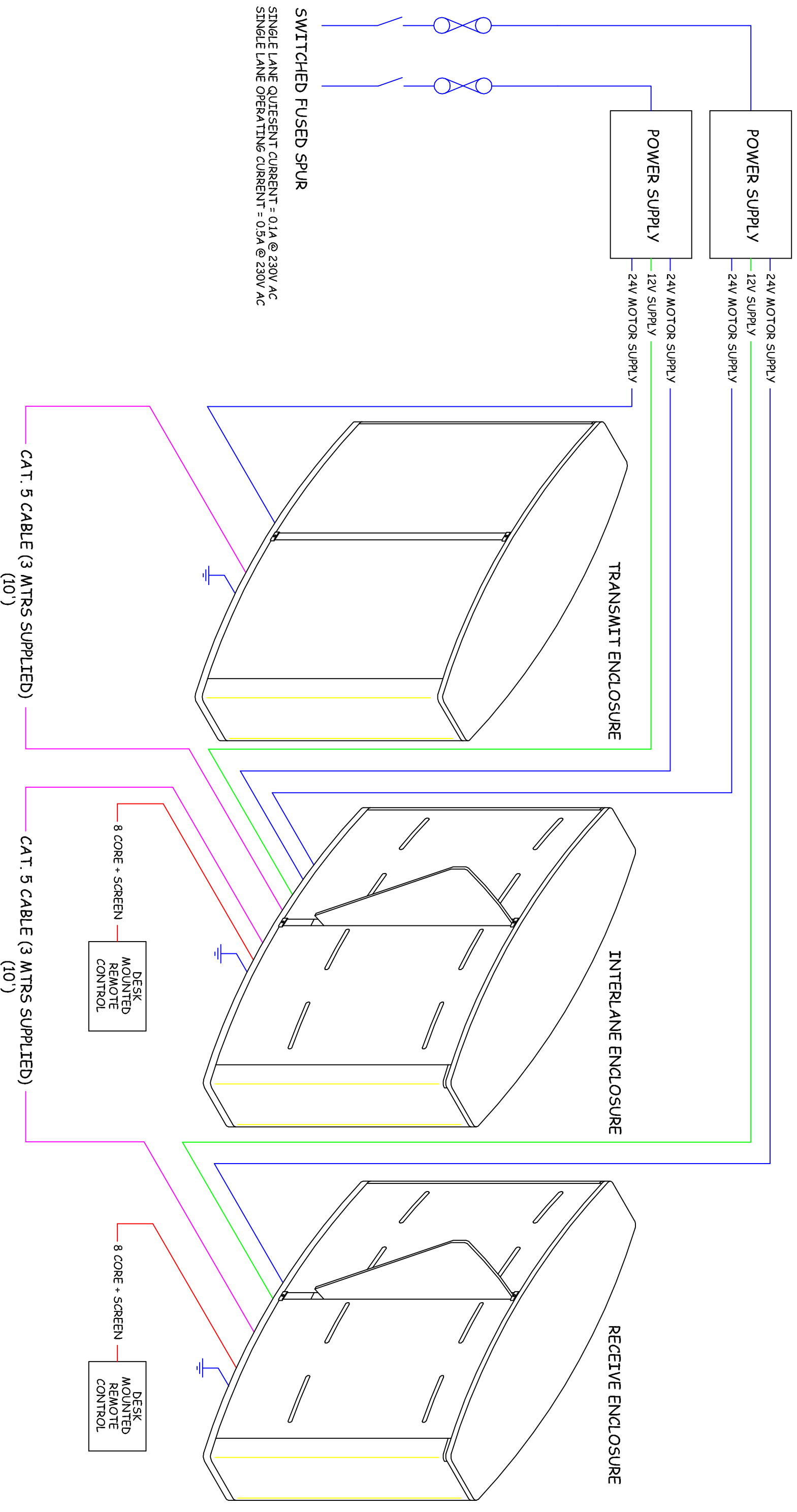

THIS DRAWING SHOWS THE GLASSWING CABLING REQUIREMENTS. IT IS TO BE READ IN CONJUNCTION WITH DRAWING 665\_488\_A0, WHICH SHOWS THE CABLING REQUIREMENTS FOR THE ACCESS CONTROL INTEGRATION. FOR FURTHER INFORMATION, REFER TO THE INSTALLATION MANUAL.

PRODUCT: GLASSWING STANDARD	
TITLE: CABLING REQUIREMENTS	
DRAWN: RST	DRAWING No: 5665_487_A0
DATE: 27.3.08	

This document is the copyright of  
Integrated Design Ltd

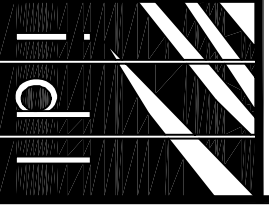

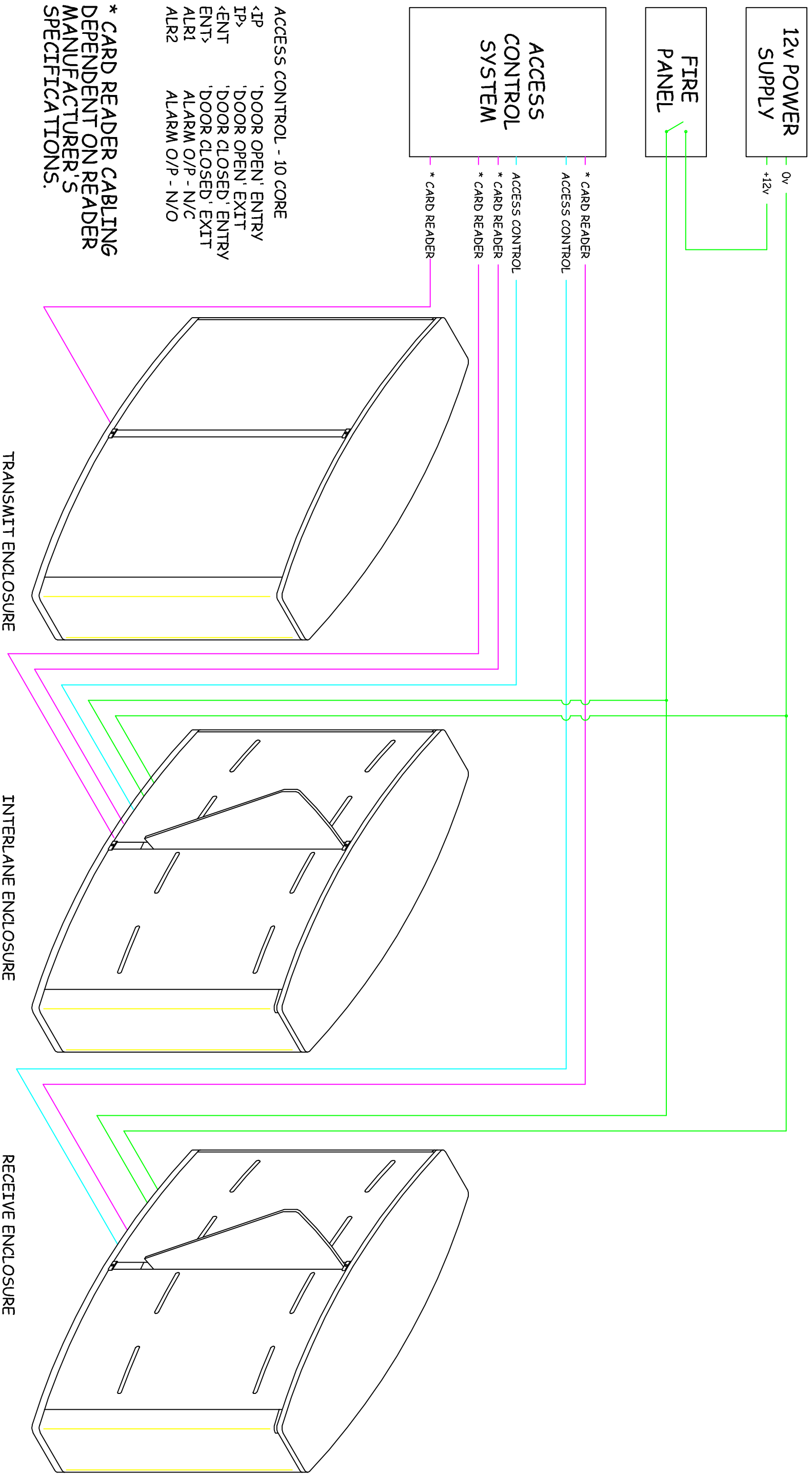

THIS DRAWING SHOWS THE ACCESS CONTROL INTEGRATION REQUIREMENTS. IT IS TO BE READ IN CONJUNCTION WITH DRAWING 665\_487\_A0 WHICH SHOWS THE GLASSWING CABLING REQUIREMENTS.

FOR FURTHER INFORMATION, REFER TO THE INSTALLATION MANUAL.

PRODUCT: GLASSWING STANDARD	
TITLE: CABLING REQUIREMENTS	
DRAWN: RST	DRAWING No: 5665_488_A0
DATE: 27.3.08	

This document is the copyright of  
Integrated Design Ltd

